

# Touchless Car Wash Equipment CBK 208



**1. 4 Type Of Automatic Chemical Mixing System**



**2. Intergrated Air Dring System**



**3. Automatic Detection Of Vehicle Length**

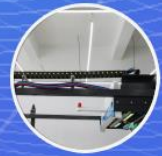

**4. Suspension System Son-Resistance Rails**





## All Functions

1	High pressure pre-wash for under chassis and wheels	10	Automatic chemical mixing system
2	360°rotating spray and wipe-free car washing liquid	11	LED arrow text remind system
3	360°rotating spray high foam car washing liquid	12	Parking guidance system
4	High pressure flush standard/powerful free switching	13	Indicating parking range
5	Magic color polish shampoo	14	Automatic detection of vehicle length
6	360°degree horizontal spray Water wax coating	15	Intelligent electronic collision avoidance
7	Intergrated air dring system (4 fans/Standard/powerful free switch) All-plastic fan	16	Mechanical hardware collision avoidance
8	Program customization	17	Security alarm system
9	Colorful light	18	Auto standby function

## Main Function Introduction

Features	Instruction
<b>Flush chassis and hubs system</b>	Equipped with the function of cleaning the chassis and wheel hub, the nozzle pressure can reach 8-9 MPa.
<b>Interated chemical mixing system</b>	Automatically adjust the ratio of a variety of liquids, including: ordinary car washing liquid, water flooding coating wax, and no-scrub car washing liquid
<b>High pressure flushing (standard/strong)</b>	The water pressure of the water pump nozzle can reach 10 MPa, and the robot arms of all equipment wash the body at a constant speed and pressure. Two modes (standard/power) can be selected.
<b>Water wax coating</b>	A macromolecular chloride is generated in the car body, which plays a role in preventing acid rain, pollution, and ultraviolet rays.
<b>Built-in compressed air drying system (all-plastic fan)</b>	The built-in air-drying system is equipped with four 5.5 kW fans, which can effectively air-dry the whole body of the vehicle, and there is no dead angle in 360 degrees.
<b>Intelligent 3D detection system</b>	Equipped with advanced ultrasonic sensors, smart photoelectric sensors and closed-loop controllers, it uses an accurate closed-loop detection system to detect the length of the vehicle to ensure stability, safety, and energy saving.
<b>Intelligent electronic collision avoidance system</b>	Carry out vehicle cleaning under the premise of ensuring safety, and carry out safety protection for various emergencies.
<b>Parking guidance system</b>	Guide the vehicle to park by reminding lights to avoid danger.
<b>Security alarm system</b>	When the equipment fails, the light and sound will prompt at the same time, and the equipment will stop running at the same time.

## Main Function Introduction

Features	Instruction
<b>Security alarm system</b>	When the equipment fails, the light and sound will prompt at the same time, and the equipment will stop running at the same time.
<b>Remote control</b>	Through the Internet of Things technology, complete remote startup, shutdown, reset, diagnosis, upgrade, operation, remote liquid level monitoring and other operations.
<b>Standby mode</b>	If the device is not used for a long time, it will automatically enter the standby state, which can reduce the energy consumption of the device in the idle state by 85%.
<b>Fault self-check</b>	When the equipment is abnormal, start the self-check and alarm procedures, identify the cause of the fault and record the fault code, which is convenient for query and maintenance.
<b>leakage protection</b>	It is used to protect the staff who may get an electric shock in the event of a leakage fault. At the same time, it has overload and short-circuit protection functions, which can be used to protect the circuit and the motor from overload and short-circuit.
<b>A free upgrade</b>	The program version is free to upgrade for life, so that your car washing machine will never be outdated.
<b>Strengthen the front and rear washing</b>	The German PINFL high-pressure industrial water pump is used to ensure that the nozzle water pressure reaches 10 MPa, which can truly achieve high-pressure washing and sweep stubborn stains.
<b>Separation of water and electricity</b>	No electrical appliances are exposed to the outside of our mainframe rack, and put the control box and wires in the storage room. This ensures safety and reduces failures.
<b>Separation of water and foam</b>	We set up two pipelines to spray water and foam separately, the single foam tube we designed is more than 2/3 less wasteful than the ordinary car washing machine.

## Main Function Introduction

Features	Instruction
<b>Direct drive system</b>	The use of new direct drive technology has greatly improved the energy saving, safety and stability of the equipment.
<b>Hot dip galvanized frame double anticorrosive</b>	The overall hot-dip galvanized frame is anti-corrosive and wear-resistant for up to 30 years, and can be simply adjusted according to the installation height.
<b>Frequency conversion energy saving system</b>	Advanced frequency conversion technology realizes the stage adjustment of chassis flushing water pressure, body flushing water pressure, and body drying air pressure. Various pressures can be adjusted according to the adjustment of climate and temperature to achieve the maximum optimization of energy saving and cleaning effects.
<b>Oil free (reducer 、 bearing)</b>	Equipped with NSK bearings originating in Japan as standard, which is oil-free and fully sealed, and is maintenance-free for life.

**Main Configuration** Non-contact



208 Touchless car wash equipment

Main configuration	Unit	QTY
Main Structure (Stainless Steel)	Set	1
Touch Screen Operating System	Set	1
Electric Distribution System	Set	1
High Pressure Water Spray System	Set	1
Foam Wax System	Piece	1
Walking System	Piece	1
Robotic Arm	Set	1
Ultrasonic Detection System	Set	1
Suspension System	Set	1
Pneumatic Control System	Set	1

## Main Parameters

Non-contact

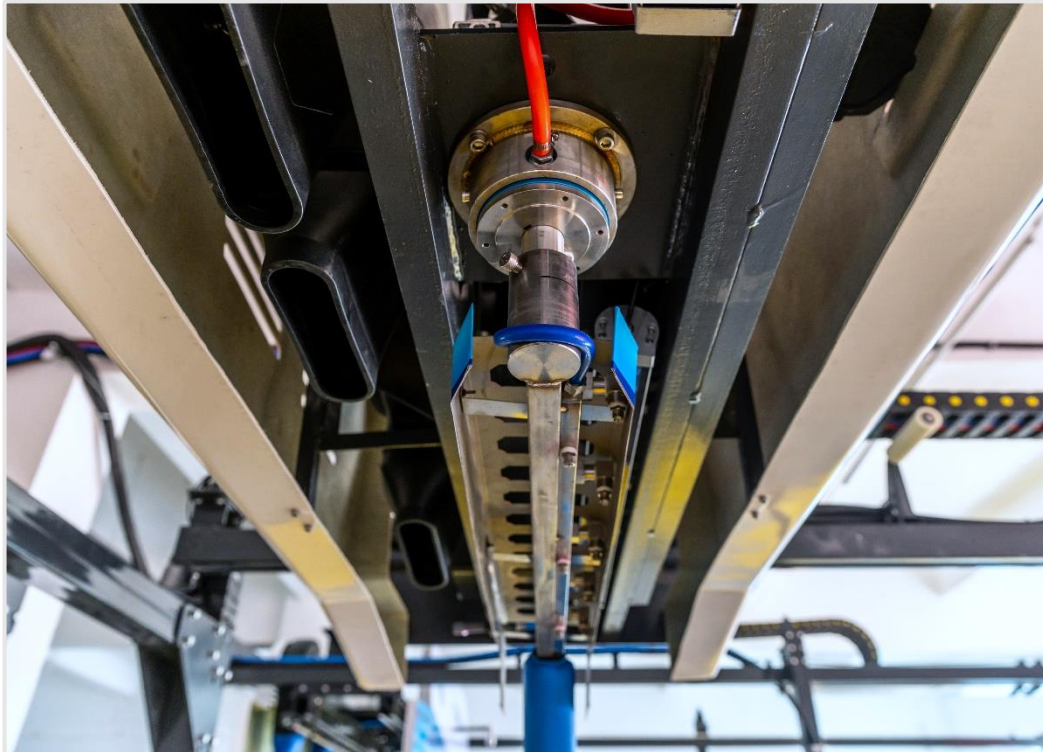

## Technical Parameters

Parameters	CBK208
Warranty	3 years
Appearance size of equipment	L7*W3.65*H3.1(M)
Installation Size	L7*W3.8*H3.2(M)
Ground concrete thickness of the site	More than 15 cm and be horizontal
Water Pump	GB 6 Motor 15KW/380V
Air-drying motor	Four 5.5KW motors/380V
Pump pressure	10 MPa
Standard water consumption	90-140L/Car
Standard power consumption	0.5-1.2 kWh
Standard chemical liquid consumption	20ML-150ML
Rail length	6.3M
Total power	15KW+22KW
Total Weight	1800KG
Shipping volume	8CBM
Power requirement	22KW、380V/Customize



## Optional Function

Optional Function	Instruction
24 Hours Self-Service Online Payment	Equipped with a mobile phone scan code payment system, in the case of unattended, car owners can scan the code to pay for self-service car wash, and choose the car wash mode and price in the program. The car wash shop can be unattended 24 hours a day.
Fast Automatic Lifting Door	When the vehicle enters or exits, the safety door will automatically rise and fall quickly, which can save time.
Water Treatment System	The sewage can be recycled and reused, and the sewage treatment system can also be customized according to the local national wastewater discharge standards.
One Button Emptying Of Sprinkler Pipes And Foam Pipes	Can drain the residual liquid in the pipeline, in order to prevent the pipeline from being unusable due to low temperature freezing.
Works When The Power Is Turned Off	If there is a sudden power failure, the continuous working mode will be activated to prevent the vehicle from being trapped during the cleaning process.
Remote Control	Integrating the latest cutting-edge technologies such as Internet of things, can realize remote start, close, reset, diagnosis and other operations.

# Core Parts



HMI



Frequency Converter



Hybrid Stepper Servo Driver



PLC Control System



Variable Frequency Motor



Proximity Switch

# Core Parts



Ultrasonic Sensor



High Pressure Water Pump

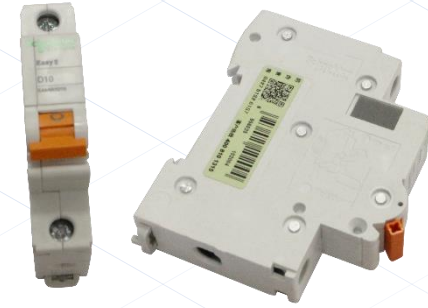

Breaker



NSK Bearing



Proportioning System



The Photoelectric Correlation

# The Installation

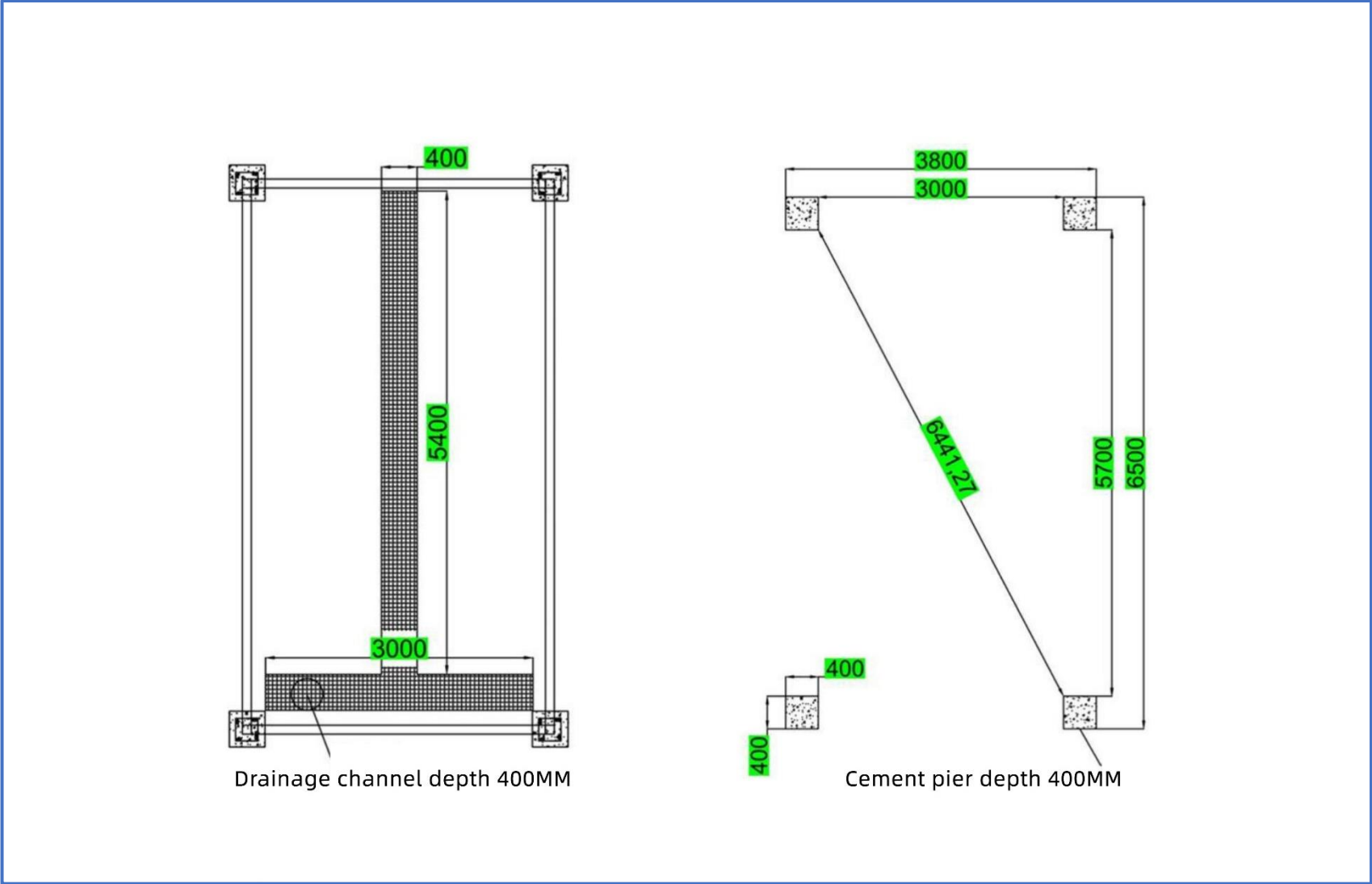

# Installation Diagram

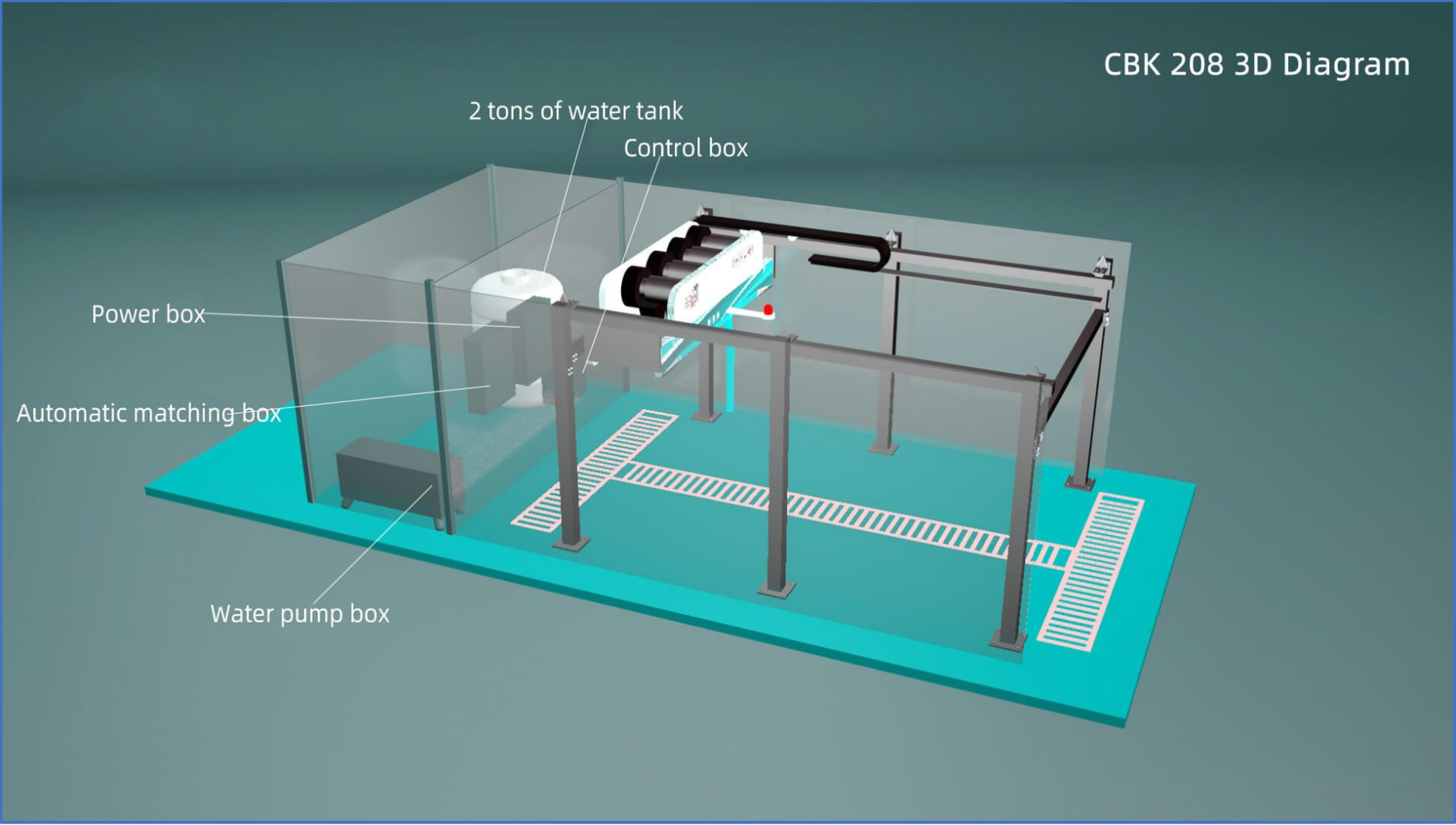

# Policy Support



Installation Support



Custom Support



Equipment Support



Spare Parts Support



Track After-sale



Training Support



Marketing Support



Design Support



3 Years Warranty



System Free Upgrade Service



Optional Function



Technical Support



Operations Support

# CONTACT US

CBK Wash

WEB: [www.cbkcarwash.com](http://www.cbkcarwash.com)



Email: [jassie@cbkcarwash.com](mailto:jassie@cbkcarwash.com)



LinkedIn: CBK Carwash



Facebook: [cbkcarwash](https://www.facebook.com/cbkcarwash)



YouTube: CBK Carwash



TikTok: CBK Carwash



TEL: +86 18904079192